

NEW

Express & Savana

Upfit Guide



NOW FEATURING

Packd Products

**WORK VEHICLES
THAT WORK BETTER!**

advantage
OUTFITTERS

What's the Advantage?



We make it Easy

- Simplified layout and design process
- Technical support and configuration assistance

We make it Fast

- Everything in this catalog is in stock
- Installs within 48 hours or less

We make it Last

- Certified and trained Installers
- Lifetime Installation Warranty

A simple 6 step process to an efficient work van

01. Start with **Interior Finishing**
02. Add a **Safety Partition**
03. Choose your **Shelving Package**
04. Add time-saving **Interior Accessories**
05. Select your **Roof Equipment**
06. Finish with **Exterior Accessories**

Advantage Outfitters is a commercial vehicle upfitter, specializing in storage equipment and accessories for cargo vans. With 20+ years of experience, we have earned the trust of contractors, trade fleets, utilities, municipalities, vehicle dealers, and leasing companies. We are defined by our strong team spirit and our passion for making work vehicles work better.

Contents

Interior Finishing	04 - 07
Wall Liners	04
Flooring	05
Logistic Equipment	06
Interior Lighting	07
Safety Partitions	08 - 09
Straight Partitions	08
Contoured Partitions	09
Shelving Packages	12 - 17
Base	12
General Service	13
HVAC	14
Plumbing	15
Electrical	16
Delivery	17

Interior Accessories	19-25
Side-Door Drawer Systems	19
Parts Keepers	20-21
Drawer Cabinets	22
Shelving Accessories	23
Cab Accessories	24
Bottle Holders	25
Roof Equipment	26 - 29
Side Dropdown	26
Clamp-down Racks	27
Cargo Racks	28
Ladder Rack Accessories	29
Exterior Accessories	30 - 31
Running Boards / Hitches	30
Security	31
Specialty Equipment	32-35
Climate Control	32
Inverters	33
Liftgates	34
Vehicle Layouts	35



sales@advantageoutfitters.com

866.925.4844
advantageoutfitters.com

vanLiner Wall and Door Protection

- Protect your vehicle investment
- 3/16" gray plastic
- Highly durable & impact resistant



Model	Wall Panels Part#	Door Panels Part#	Model	Wall Panels Part#	Door Panels Part#
Regular 135" WB with hinged side doors	601G1WL	601GXDPB	Extended 155" WB with hinged side doors	601G2WL	601GXDPB
Regular 135" WB with sliding side door	601G1WL	601GXDP	Extended 155" WB with sliding side door	601G2WL	601GXDP

Duratherm Insulated Kits

- 5/16" Heavy-duty rigid gray plastic door protection including a layer of foil/foam insulation attached to the back of the panels
- Provides sound deadening and an R4 equivalent thermal barrier

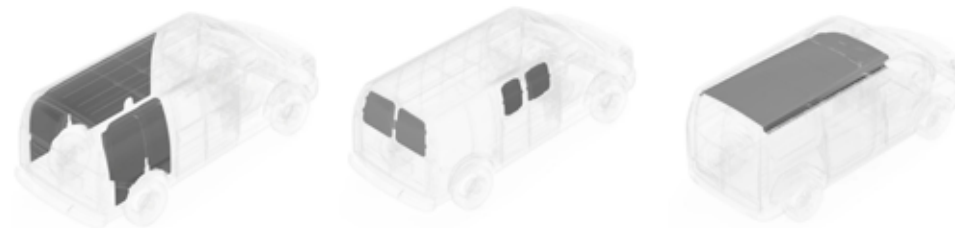

Insulation kits also available, call for details

Model	Wall Liners Part#	Door Liners Part#	Ceiling Liners Part#
Regular 135" WB with hinged side doors	654G1WL	654GXDPB	654G1CL
Regular 135" WB with sliding side door	654G1WL	654GXDP	654G1CL
Extended 155" WB with hinged side doors	654G2WL	654GXDPB	654G2CL
Extended 155" WB with sliding side door	654G2WL	654GXDP	654G2CL

Floor Protection

Rubber Mat

- 1/4" virgin rubber resists oils and chemicals
- Saves knees and increases traction
- One piece seamless



Model	Rubber Mat Part #
Regular 135" WB	654G1RM
Extended 155" WB	654G2RM

StabiliGrip Floor

- 1/2" rubberized plastic with fiberglass reinforcement
- Provides firm base for tools and equipment
- Durable, non-skid surface



Model	Stabiligrip Part #
Regular 135" WB	654G1SG
Extended 155" WB	654G2SG

Door Sills

- Custom fit, heavy-duty diamond plate aluminum sill plates
- Protects entry points and provides traction

Description	Door Sill Part #
Set of 2 for Side & Rear Doors	654GXRSS



Side Door Sill



Rear Door Sill

Our 6 Step Process

Start with Interior Finishing 01

Add a Safety Partition 02

Choose your Shelving Package 03

Add time-saving Interior Accessories 04

Select your Roof Equipment 05

Finish with Exterior Accessories 06

INTERIOR FINISHING

INTERIOR FINISHING

Aluminum Lashing Rail Kit

- Durable & versatile
- Kit includes 1 level of track for both side walls
- Includes 5 movable tie-down rings
- Ratchet straps also available



Model	Lashing Rail Kit Part #	8' Ratchet Strap	6' Cam Buckle Strap
Regular 135" WB	842G1LK	842XX8RB	842XX6CB
Extended 155" WB	842G2LK	842XX8RB	842XX6CB

Seat Covers

- Custom-fit
- Tough Cordura fabric



Description	Part#
Seat Covers (set of 2)	876GXSC

Window Grills

- Black painted wire mesh construction

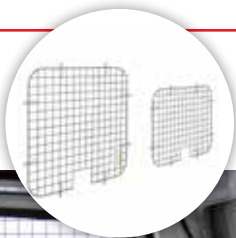

Description	Part#
Rear Doors	876GXRG
Side doors (barn/hinged doors only)	876GXSGB

Strip Lighting

- High intensity 2' LED light
- Mounts to side of ceiling ribs to maintain headroom
- Light is not compatible with ceiling liners
- Wired with OEM (door) switch
- 2 recommended for Regular 135" WB vans
- 3 recommended for Extended 155" WB vans



Description	Part#
Single 2' LED light	452XXLD2

Motion Sensor Lighting

- Motion sensor activated
- Recommended for install with Duratherm ceilings
- 2 recommended for the regular 135" WB vans
- 3 recommended for the extended 155" WB vans



Description	Part#
1 LED light kit	454XXLK1
2 LED lights kit	454XXLK2
3 LED lights kit	454XXLK3
Bracket and hardware kit	454XXBH*

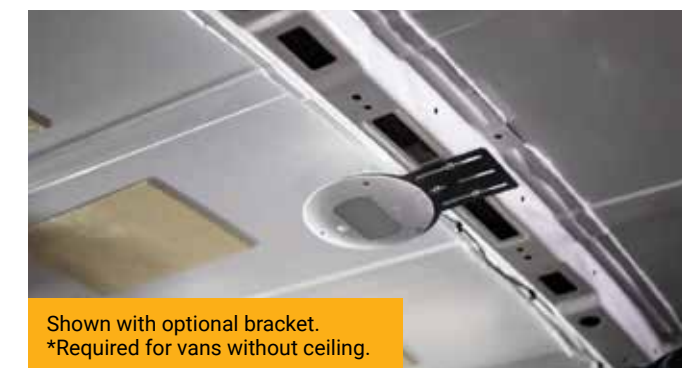

Shown with optional bracket.
*Required for vans without ceiling.



INTERIOR FINISHING

INTERIOR FINISHING

Partitions Without Door

Steel

- Heavy gauge white powder-coated steel
- Includes hatch in bottom of center panel for long material
- Mesh upper on center & passenger side panels for increased visibility
- 7" setback for maximum seat travel



Steel Partition

Aluminum Partition

Aluminum

- Lightweight & durable aluminum
- Rattle-free design
- Mesh upper on center panel
- 4" setback for seat travel

Description	Part#
Steel Partition Without Door	287GXSP
Aluminum Partition Without Door	P40-GMS

Composite Partitions

- One-piece design
- Innovative design maximizes both driver comfort and storage space
- Perfect fit provides improved climate control and noise reduction
- Available with or without polycarbonate window



Solid Composite

Solid Composite with Window

Description	Part#
Solid Composite Partition	187GXCP
Composite Partition with Window	187GXCPW

Partitions With Door

Steel

- Heavy gauge white powder-coated steel
- Includes hatch in bottom of center panel for long material
- Mesh upper on center & passenger side panels for increased visibility
- 7" setback for maximum seat travel



Steel Partition

Aluminum Partition

Aluminum

- Lightweight & durable aluminum
- Rattle-free design
- Mesh upper on center panel
- 4" setback for seat travel
- Includes hinged latching door for access to cargo area



Description	Part#
Steel Partition With Door	287GXHDP
Aluminum Partition With Door	P50-GMS

Aluminum Partitions

- Lightweight & durable aluminum
- Rattle-free design
- Maximize seatback travel while increasing cargo floor area
- Available with or without window for visibility



Contoured Solid Partition

Contoured Partition with Window

Description	Part#
Contoured Aluminum Partition	P10-GMS
Contoured Aluminum Partition with Window	P11-GMS

INTERIOR FINISHING

INTERIOR FINISHING

Increase your productivity with our Trade-Specific Packages



What's the Packd Advantage?



Durable



Load tested to **1200 lbs** per shelf

Secure

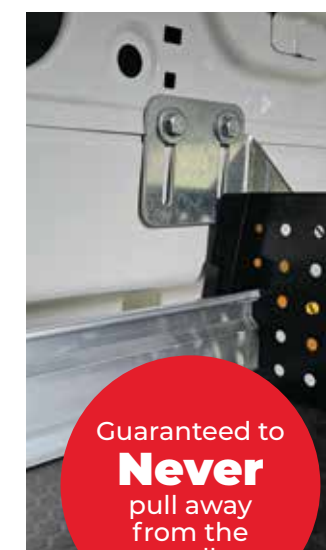

Guaranteed to **Never** pull away from the wall

Lightweight

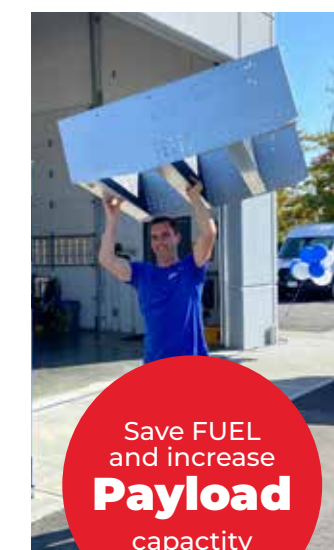

Save **FUEL** and increase **Payload** capacity

Quiet

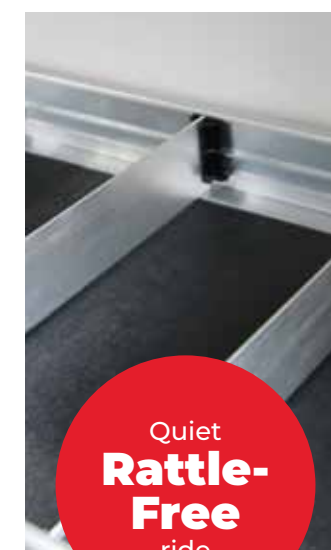

Quiet **Rattle-Free** ride

Here's what our customers say about their upfitted vans

"My technicians are able to keep the vans organized, which increases our overall efficiency."



Mike S.
HVAC Service Company.

"You really helped us get the maximum benefit out of our vehicles."



Michael R.
Fire Protection Company.

Our 6 Step Process

- Start with Interior Finishing
01
- Add a Safety Partition
02
- Choose your Shelving Package
03
- Add time-saving Interior Accessories
04
- Select your Roof Equipment
05
- Finish with Exterior Accessories
06

SHELVING PACKAGES

Base Package

Choose your partition

- Straight Partition
- Swing Door Partition
- No Partition

Driver's side includes:

- (1) Aluminum 3 Shelf Unit, 45"H x 84"L - (Depths:12,14,14)

Passenger's side includes:

- (1) Aluminum 3 Shelf Unit, 45"H x 48"L - (Depths: 12,14,14)

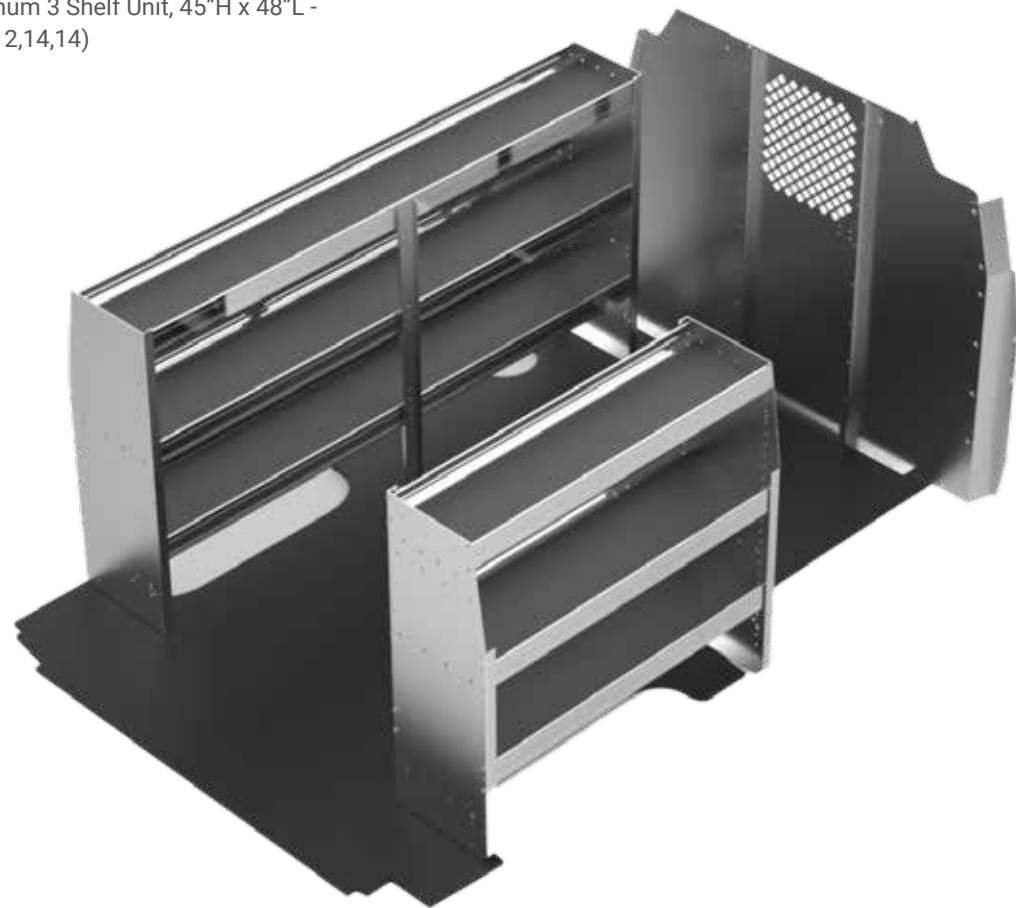

NOTE
96" DS shelving unit is also available.
*Flooring not included in shelving packages.



Model	Part#
Base Package with Straight Partition	175GXBP
Base Package with Swing Door Partition	175GXBD
Base Package with No Partition	175GXBPX

General Service Package

Choose your partition

- Straight Partition
- Swing Door Partition
- No Partition

Driver's side includes:

- (1) Aluminum 3 Shelf Unit, 45"H x 84"L - (Depths:12,14,14)
- (10) adjustable 3" rattle-free dividers
- (2) 18.5"W x 10.5"H 2-drawer cabinets
- (1) fixed hook

Passenger's side includes:

- (1) Aluminum 3 Shelf Unit, 45"H x 48"L - (Depths: 12,14,14)
- (4) 14"D x 12"W plastic bins
- (1) swivel hook



NOTE
96" DS shelving unit is also available.
*Flooring not included in shelving packages.



Model	Part#
General Service Package with Straight Partition	175GXGSP
General Service Package with Swing Door Partition	175GXGSPD
General Service Package with No Partition	175GXGSPX

HVAC Package

Choose your partition

- Straight Partition
- Swing Door Partition
- No Partition

Driver's side includes:

- (1) Aluminum 3 Shelf Unit, 45"H x 84"L - (Depths:12,14,14)
- (7) 14"D x 12"W plastic bins with dividers
- (1) large gas bottle holder
- (1) fixed hook

Passenger's side includes:

- (1) Aluminum 3 Shelf Unit, 45"H x 48"L - (Depths: 12,14,14)
- (10) adjustable 3" rattle-free dividers
- (1) 43"H x 13.5"W 3-level refrigerant rack
- (1) swivel hook



NOTE
96" DS shelving unit is also available.
*Flooring not included in shelving packages.

Packd

Model	Part#
HVAC Package with Straight Partition	175GXHP
HVAC Package with Swing Door Partition	175GXHPD
HVAC Package with No Partition	175GXHPX

Plumbing Package

Choose your partition

- Straight Partition
- Swing Door Partition
- No Partition

Driver's side includes:

- (1) Aluminum 3 Shelf Unit, 45"H x 84"L - (Depths:12,14,14)
- (10) adjustable 3" rattle-free dividers
- (1) large gas bottle holder
- (1) fixed hook

Passenger's side includes:

- (1) Aluminum 3 Shelf Unit, 45"H x 48"L - (Depths: 12,14,14)
- (8) 14"D x 12"W plastic bins with dividers
- (4) 12"D x 12"W plastic bins with dividers
- (1) large gas bottle holder
- (1) swivel hook

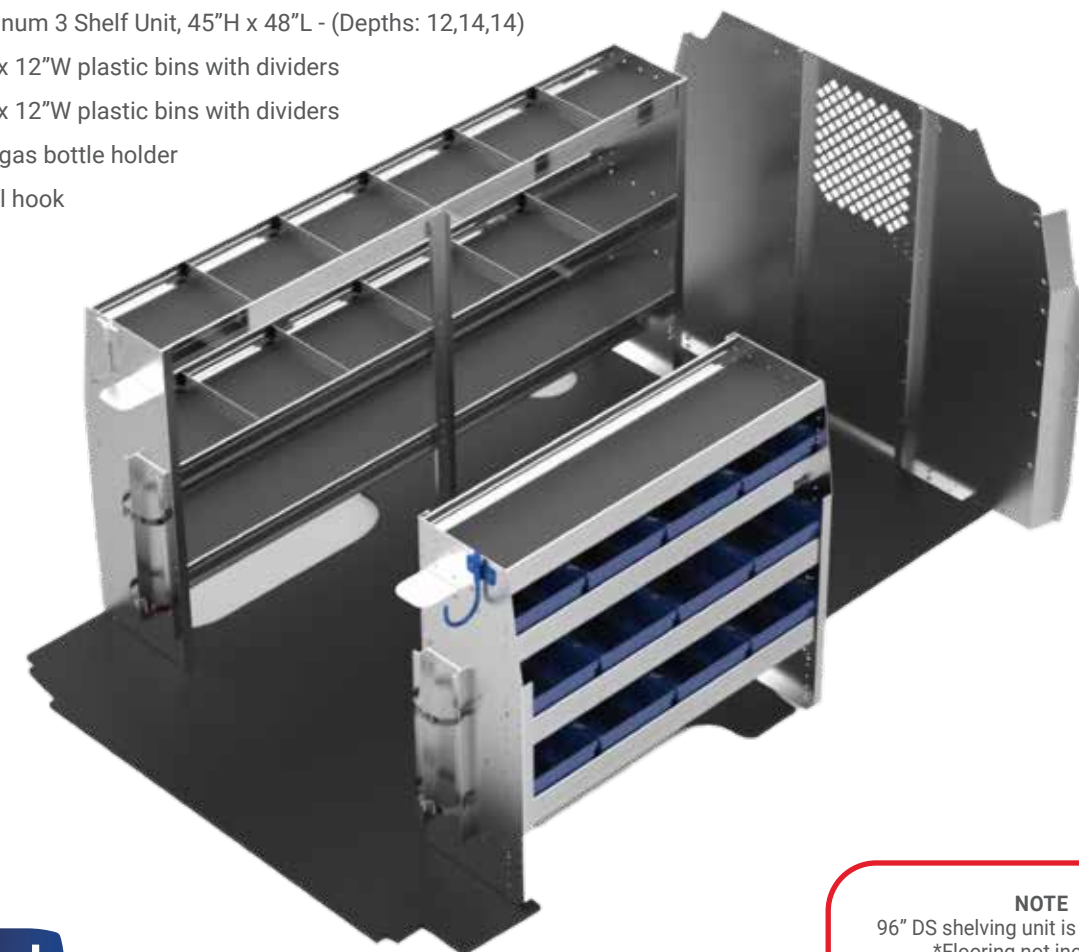

NOTE
96" DS shelving unit is also available.
*Flooring not included in shelving packages.

Packd

Model	Part#
Plumbing Package with Straight Partition	175GXPP
Plumbing Package with Swing Door Partition	175GXPPD
Plumbing Package with No Partition	175GXPPX

Electrical Package

Choose your partition

- Straight Partition
- Swing Door Partition
- No Partition

Driver's side includes:

- (1) Aluminum 3 Shelf Unit, 45"H x 84"L - (Depths:12,14,14)
- (7) 12"D x 12"W plastic bins with dividers
- (1) 11"H x 48"L locking cabinet
- (1) 11"H x 36"L locking cabinet
- (1) wire reel holder
- (1) fixed hook

Passenger's side includes:

- (1) Aluminum 3 Shelf Unit, 45"H x 48"L - (Depths: 12,14,14)
- (10) adjustable 3" rattle-free dividers
- (1) swivel hook

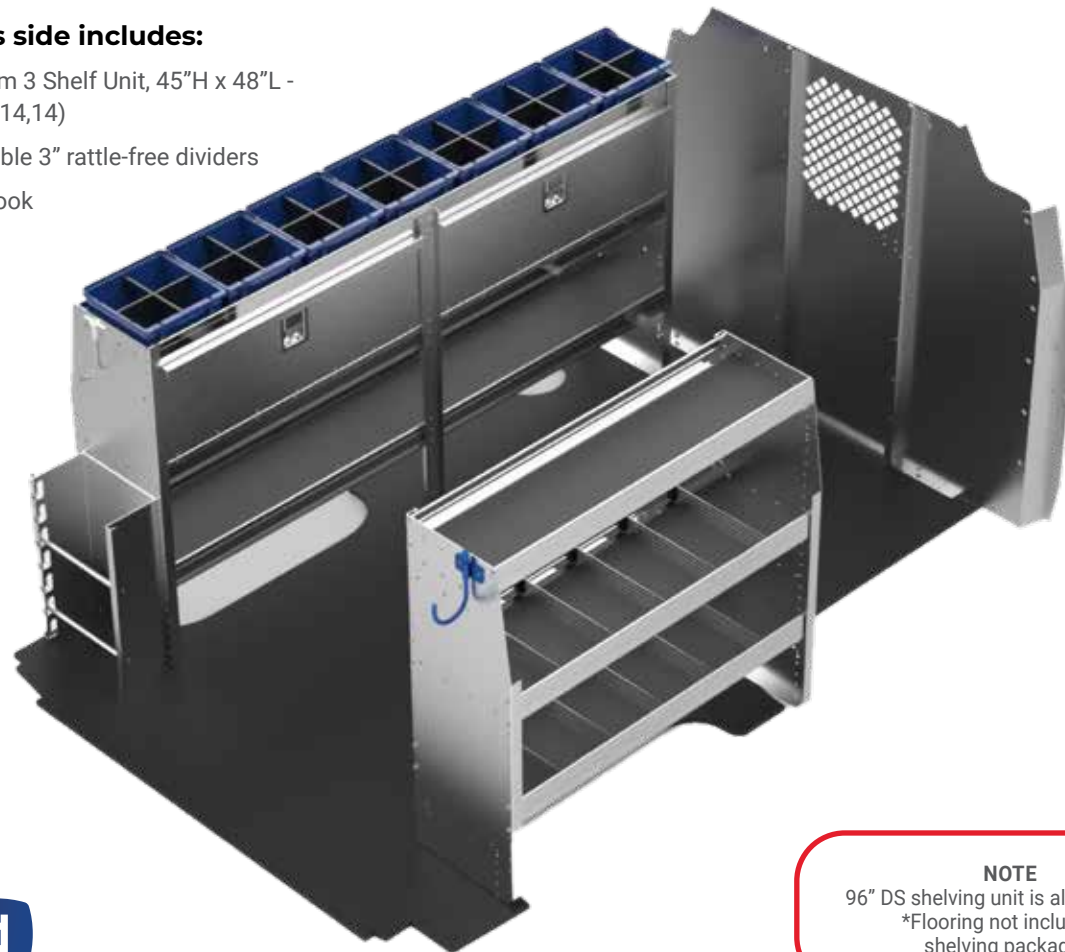

NOTE
96" DS shelving unit is also available.
*Flooring not included in shelving packages.

Packd

Model	Part#
Electrical Package with Straight Partition	175GXEP
Electrical Package with Swing Door Partition	175GXEPD
Electrical Package with No Partition	175GXEPX

Delivery Package

Choose your partition

- Pass-Thru Partition
- Swing Door Partition
- No Partition

Driver's side includes:

- (1) 48"H x 72"L - 2 shelf unit with folding shelves

Passenger's side includes:

- (1) 48"H x 48"L - 2 shelf unit with folding shelves
- Folding shelves keep aisle clear when not in use
- Gas shock holds shelf in either up or down position - no latches or rattles
- Capacity is 250 lbs per shelving unit
- Shelves are 18" deep



Model	Part#
Delivery Package with Pass-Thru Partition	175GXDP
Delivery Package with Swing Door Partition	175GXDPD
Delivery Package with No Partition	175GXBPX

**DO YOU HAVE
A FLEET OF
10+ VANS?**

Contact us to learn about
our fleet upfit solutions





Switching
your fleet to
brightdrop?

We can help make the
transition easy while
maximizing your range

Organized Time Saver

Access your most common items without even entering your vehicle.

Build a drawer system that works best for you

01. Start with a **Tool Drawer** for power tools and bags
02. Add **Parts Drawers** for hand tools and components
03. Finish with a **Top Tray** and crates or a **Worktop** surface



Our 6 Step Process

Start with Interior Finishing 01

Add a Safety Partition 02

Choose your Shelving Package 03

Add time-saving Interior Accessories 04

Select your Roof Equipment 05

Finish with Exterior Accessories 06

Tool Drawer

- Aluminum
- Weight capacity: 320 lbs
- Includes 3 large dividers
- Gray powder-coated drawer face
- 17"W x 45"L x 19.5"H
- Lockable



Description	Part#
Tool Drawer	DR10

Parts Drawer

- Aluminum
- Weight capacity: 150 lbs
- Drawer has paddle latch
- Gray powder-coated drawer face
- 12.5"W x 45"L x 7.5"H
- Lockable



Description	Part#
Parts Drawer	DR11



Tool Drawer Top Tray

- Turn your drawer top into additional organization
- 16"W x 45"L x 4"H

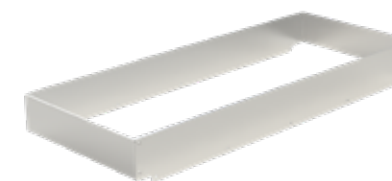

Description	Part#
Top Tray for Tool Drawer	TE10

Parts Drawer Top Tray

- Turn your drawer top into additional organization
- 16"W x 45"L x 4"H

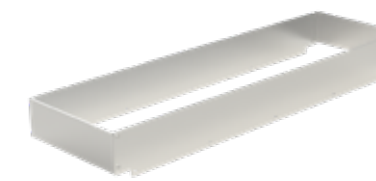

Description	Part#
Top Tray for Parts Drawer	TE11

Add a Worktop to Your Drawer System

- 18"D x 48"W hardwood butcher block top
- Mounts to top of drawer system



Description	Part#
Drawer System Worktop	176XWT

Maximize your Productivity!

Bring all of your small parts in one trip

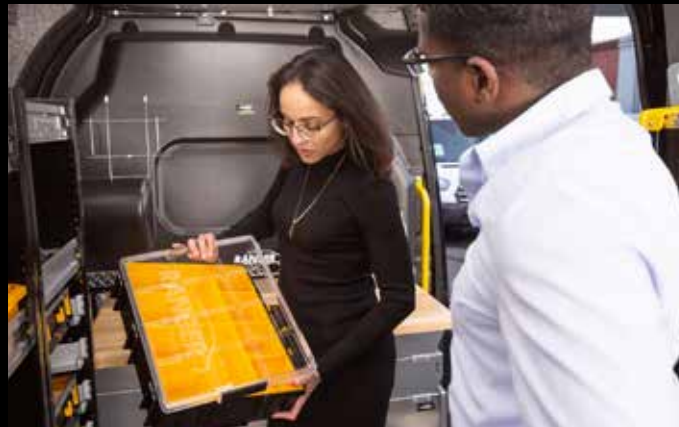

Incorporate time saving Parts Keepers into your upfit:

1) Add single Parts Keeper units onto your shelves

2) Mount a Parts Keeper cabinet at your side door for easy access



Parts Keeper Case

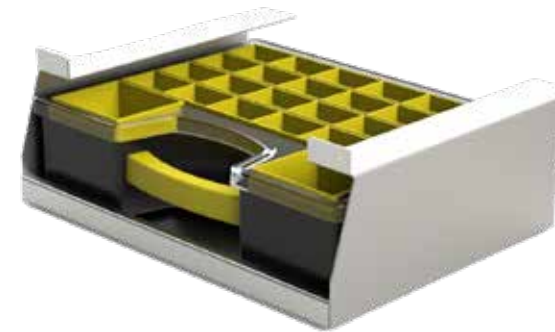

Be Efficient!

Saving just 5 minutes per day will gain you 21 hours per year!

Description	Part#
Parts Keeper Case	PK-1

4 Pc. Parts Keeper Cabinet

- 1 Shelf
- Aluminum
- 17"W x 13.5"D x 24"H

5 Pc. Parts Keeper Cabinet

- 2 Shelves
- Aluminum
- 17"W x 13.5"D x 45"H

8 Pc. Parts Keeper Cabinet

- 1 Shelf
- Aluminum
- 17"W x 13.5"D x 45"H

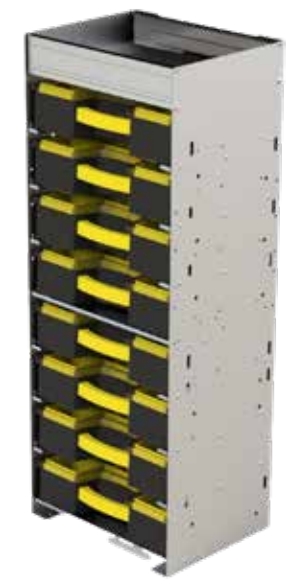

Description	Part#
4 Pc. Parts Keeper	PK-4-1

Description	Part#
5 Pc. Parts Keeper	PK-5-2

Description	Part#
8 Pc. Parts Keeper	PK-8-1

2-Drawer & 3-Drawer Cabinets:

- Latching drawers with ball bearing slides
- Includes key lock for security
- Cabinets can be individually mounted to shelves or stacked on floor
- 12.5"D x 18.5"W x 10.5"H

9-Drawer Cabinet:

- Rattle-free plastic drawers with dividers
- Includes built-in drawer catch
- 12.5"D x 17"W x 12"H



Contractor Approved

The drawers are super smooth and I couldn't be happier with them. High quality item. **99**

Leslie N.

Locking Door



Description	Part#
45"W x 10"H Locking Door (5 hole spacing for 48"W shelving unit)	SD1045
45"W x 11.5"H Locking Door (6 hole spacing for 48"W shelving unit)	SD1145*
45"W x 13"H Locking Door (7 hole spacing for 48"W shelving unit)	SD1345

*Default size/shelf spacing

Dividers (Pack of 5)

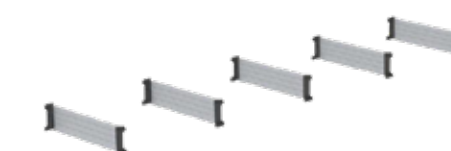

Description	Part#
11" Aluminum Shelf Dividers	CDS-11
12" Aluminum Shelf Dividers	CDS-12
14" Aluminum Shelf Dividers	CDS-14

Bins



Includes a center & cross divider



Description	Part#
11"D Plastic Bin	PBS-11
12"D Plastic Bin	PBS-12
14"D Plastic Bin	PBS-14

2-Drawer Cabinet



Description	Part#
2-Drawer Cabinet	876XX2DC

3-Drawer Cabinet



Description	Part#
3-Drawer Cabinet	876XX3DC

9-Drawer Cabinet

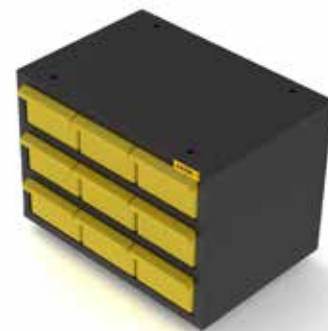

Description	Part#
9-Drawer Cabinet	876XX9DC

Moveable Hooks

- Use two large hooks to hang ladder from shelving
- Clips to shelving lip



Description	Part#
Small Ladder Hook	AC74
Large Ladder Hook	AC73

Swivel Hook

- Powder-coated blue finish



Description	Part#
Swivel Hook	AC72

Fixed Hook



Description	Part#
Fixed Hook (3" opening)	AC70
Large Fixed Hook (4" opening)	AC71

INTERIOR ACCESSORIES

INTERIOR ACCESSORIES

Cab Organizer Box



Description	Part#
Locking Aluminum Cab Box Organizer	CL10

Paper Holders



Description	Part#
Aluminum 3-Slot Paper Holder	AC10
Aluminum 5-Slot Paper Holder	AC14

First-Aid Kit



Description	Part#
First-Aid Kit With Holder	864XXFA

Triangle Kit



Description	Part#
Triangle Kit	876XXTK

Hard Hat Holder



Description	Part#
Hard Hat Holder	876XXHH

Grab Handle

- High grip surface
- Increase safety and efficiency



Description	Part#
Grab Handle	876XXGH

Small Bottle Holder

- For MC tanks



Description	Part#
Small Bottle Holder	RS86

Large Bottle Holder

- For B tanks and nitrogen tanks



Description	Part#
Large Bottle Holder	RS88

Refrigerant Rack Two Level

- For refrigerant tanks
- Keeps tanks vertical



Description	Part#
Two Level Adjustable Bottle Holder	RS10

Refrigerant Rack Three Level

- For 30lb and 50lb refrigerant tanks
- Includes shelf top of unit



Description	Part#
Large Aluminum 3 Tier Refrigerant Rack	RS-3L-1

Refrigerant Rack Four Level

- For 30lb refrigerant tanks



Description	Part#
Small Aluminum 4 Tier Refrigerant Rack	RS-4S



INTERIOR ACCESSORIES

INTERIOR ACCESSORIES

Side Dropdown Ladder Rack

Rear Dropdown Ladder Rack

optional cross bar end stops available for a single sided rack for additional roof storage capacity

MaxRack



Single Side Drop Down



Double Side Drop Down



- All aluminum construction
- Removable rotation bar included
- Single side rack holds 1 extension ladder
- Double side rack holds 2 extension ladders
- Maximum extension ladder is 32'
- Add optional third crossbar to hold stepladders, fits 8-10 foot stepladders only

Description	Part#
Single Side MaxRack for GM Van	376GXSR
Double Side MaxRack for GM Van	376GXDR

ErgoRack



- Aluminum and steel construction
- Removable rotation bar included
- Single side rack holds 1 extension ladder
- Double side rack holds 2 extension ladders
- Maximum extension ladder is 36'
- Add optional third crossbar to hold stepladders, fits 6-10' foot stepladders only

Description	Single Side Part#	Double Side Part#
ErgoRack for GM Van	374GXSR	374GXDR

Double Clamp Ladder Rack

- All aluminum construction
- Fast easy operation
- Designed for carrying (2) extension ladders
- Curved rails assist in loading long ladders
- Clamping mechanism automatically restrains ladders
- Easily add padlocks for security



Description	Part#
Double Clamp Ladder Rack	376GXCL

Combination Ladder Rack

- All aluminum construction
- Fast easy operation
- Designed for carrying (1) extension ladder and (1) stepladder
- Curved rail on passenger side assists in loading long ladders
- Stepladder rails on driver side assist in loading short ladders
- Fits 6" & 8" step-ladders
- Easily add padlocks for security



Description	Part#
Combination Ladder Rack	376GXCO

Our 6 Step Process

Start with Interior Finishing 01	Add a Safety Partition 02	Choose your Shelving Package 03
Add time-saving Interior Accessories 04	Select your Roof Equipment 05	Finish with Exterior Accessories 06

Cargo Racks

- Rust-free aluminum construction
- Includes ladder stops & straps



*optional rear roller bar

Description	Part#
2 Bar Rack	395GX2B
3 Bar Rack	395GX3B

Rear Roller

- Add to any 2 or 3 bar rack
- Aids in loading ladders & material
- Protect your vehicle & brake light from damage



Description	Part#
Rear Roller	395GXRR

Ratchet Tie-Downs

- Recommended two per side
- Safely secure any type of load



Model	Part#
Set of 2 for Cargo Racks	795XXRTH1S

Access Ladders

- Heavy duty extruded aluminum
- Contoured to fit Express/Savana
- Clamp on design eliminates holes in vehicle

Description	Part#
Access Ladder	774GXAL



Conduit Carrier

- 5" square rigid one piece design
- White powder-coated aluminum with black end caps
- Inside length of 10' 1"
- Lockable
- Add to any ladder rack



Description	Part#
Conduit Carrier	774XXCT

Grip Step Running Boards

- 7" wide stepping surface
- Black powder coat aluminum
- Open tread design for maximum grip
- 98" passenger's board and 36" drivers board



Description	Part#
Running Boards (Driver's side and passenger's side set)	760GXR

Tow Hitches

- Class III (600 lb tongue weight, 6000 lb trailer weight)
- 4-way flat & 7-way wiring systems



Duplex 4-Way Flat & 7-Way Wiring



Digital Brake Controller



Description	Part#
Hitch – Class III Hitch for All Models	706GXTH
4-Way Flat Wiring Kit	506GX4TC
Duplex 7-way/4-way Wiring Kit*	506GX7TC
Digital Brake Controller	506XXTBC

* WARNING: Requires a Digital Brake Controller to enable trailer brakes.

SecuriLock Double Slamlock

- Hardened weather-proof steel body
- Automatically locks when doors are shut
- High security key prevents duplication



Description	Part#
SecuriLock Double Slamlock (set of 2)	654XXSL

Slick Locks

- High security hasps use factory mounting points
- Solid steel "puck" style locks included
- Custom fit for drill-free installation



Description	Part#
Set of 2 Slick Locks for Vans with Sliding Side Doors	788GXSLH
Set of 2 Slick Locks for Vans with Swing Side Doors	788GXSL

Our 6 Step Process

Start with Interior Finishing 01	Add a Safety Partition 02	Choose your Shelving Package 03
Add time-saving Interior Accessories 04	Select your Roof Equipment 05	Finish with Exterior Accessories 06

EXTERIOR ACCESSORIES

EXTERIOR ACCESSORIES

HVAC Tie-In System

- Engine-driven system designed for generally moderate climates
 - Achieve an indoor temperature approximate 12-15 degrees below the maximum outside temperature
 - Adds a high-capacity evaporator in the cargo area
 - Ties in to vehicle's existing OEM compressor and condenser
 - Connects into vehicle's existing coolant lines for heat function
- Application Example:**
- Art Transport
 - Mobile Showrooms



NOTE.
Products shown on this page are not available for onsite install

Description	Part#
Tie-In HVAC System	997XXTI

HVAC Extreme Climate System

- Engine-driven system designed for the most demanding HVAC requirements
 - Achieve an indoor temperature of up to 30 degrees below the maximum outdoor temperature
 - Adds a high-capacity evaporator in the cargo area
 - Adds a powerful auxiliary compressor in the engine compartment
 - Adds an additional condenser (either rooftop mount or underbody options)
 - Connects into vehicle's existing coolant lines for heat function
- Application Example:**
- Animal Transport
 - Mobile Labs



Description	Part#
HVAC Extreme Climate System	Call for details

Fuel-fired Heaters

- High-performance combustion heater for safe, reliable heat
 - Powered through the vehicles existing fuel tank
 - Gas and diesel options
 - Pair with our auxiliary battery/charging system for vehicle-off operation
 - Compact design mounts almost anywhere on the floor
 - Uses as little as 1 gallon of fuel per 22 hour period
 - Up to 7,000 BTU/h heat output
- Application Example:**
- Carpet Cleaners
 - Mobile Pressure-Washers



Description	Part#
Fuel-Fired Heater, gas engines, with Standard Controller	997XXGSC
Fuel-Fired Heater, gas engines, with Programmable Controller	997XXPSC
Fuel-Fired Heater, diesel engines, with Standard Controller	997XXDSC
Fuel-Fired Heater, diesel engines, with Programmable Controller	997XXPSC

Compact Power Inverters

- Pure Sine Wave – safe for electronics and lithium-ion chargers
- 1,200W - 2,000W options
- Perfect for occasional and light/medium loads
- Runs most basic hand tools, chargers, and small appliances
- Single GFCI outlet built into unit



NOTE.
Products shown on this page are not available for onsite install

Description	Part#
1,200W Pure Sine Wave Inverter with cabling & fuse	596XX1.2PI
Bluetooth Adaptor for 1,200W Inverter	596XXBD
Remote Switch for 1,200W Inverter	596XXRS
2,000W Pure Sine Wave Inverter with cabling & fuse	503XX2PI-HF
Remote Switch for 2,000W Inverter	503XXRS

Heavy Duty Power Inverter/Charger Systems

- Designed for daily use in industrial applications
- 3,000W - 10,000W options
- Perfect for utilities, mobile workstations, and high-surge loads
- Hardwire only - configure with multiple outlets and shore power charging
- Bluetooth-enabled plus remote monitoring options



*110V outlets and shore power inlet not included – call to configure

Description	Part#
3000W Pure Sine Wave Inverter/Charger* with cabling & fuse	596XX3PI
5000W Pure Sine Wave Inverter/Charger* with cabling & fuse	596XX5PI
Digital Remote Control Panel	596XXRC

Auxiliary Batteries

- Enables inverter operation with vehicle off
- Provides reserve power for high-surge loads
- 100AH-460AH battery bank options
- Isolated from OEM battery for reliable starts
- Automatically charged via vehicle alternator or optional shore power



Description	Part#
100AH AGM Deep-Cycle Battery with Isolator and Battery Box	503XX1AB-B
200AH AGM Deep-Cycle Battery with Isolator and Battery Box	503XX2AB-B
Battery Monitor – Bluetooth enabled	596XXBMS

Cantilever Series

- Most popular model
- 1300 lb capacity
- Folds to allow rear door access while stowed
- 53"W x 40"L load area
- Built in cart stops



NOTE.
Products shown on this page are not available for onsite install

Description	Part#
Cantilever Liftgate for Express/Savana Vans	989GXCS*

* Available on special order only

V2 Series

- 1100 lb capacity
- Stores inside van
- 47"W x 34"L load area
- Built in cart stops



Description	Part#
V2 Liftgate for Express/Savana Vans	989GXV2*

* Available on special order only

Don't see what you're looking for?

Contact us to design a custom build, we love a challenge!



Mobile Laboratory

Challenge: A manufacturer was looking to perform climate controlled hydraulic tool calibration onsite for their customers.



Incident Command

Challenge: A regional OEM was looking to manage agency communications and radio distribution at major emergency scenes.



Mobile Showroom

Challenge: A luxury stone & tile distributor was looking to grow their business by bringing their showroom to their clients.

Regular 135" WB

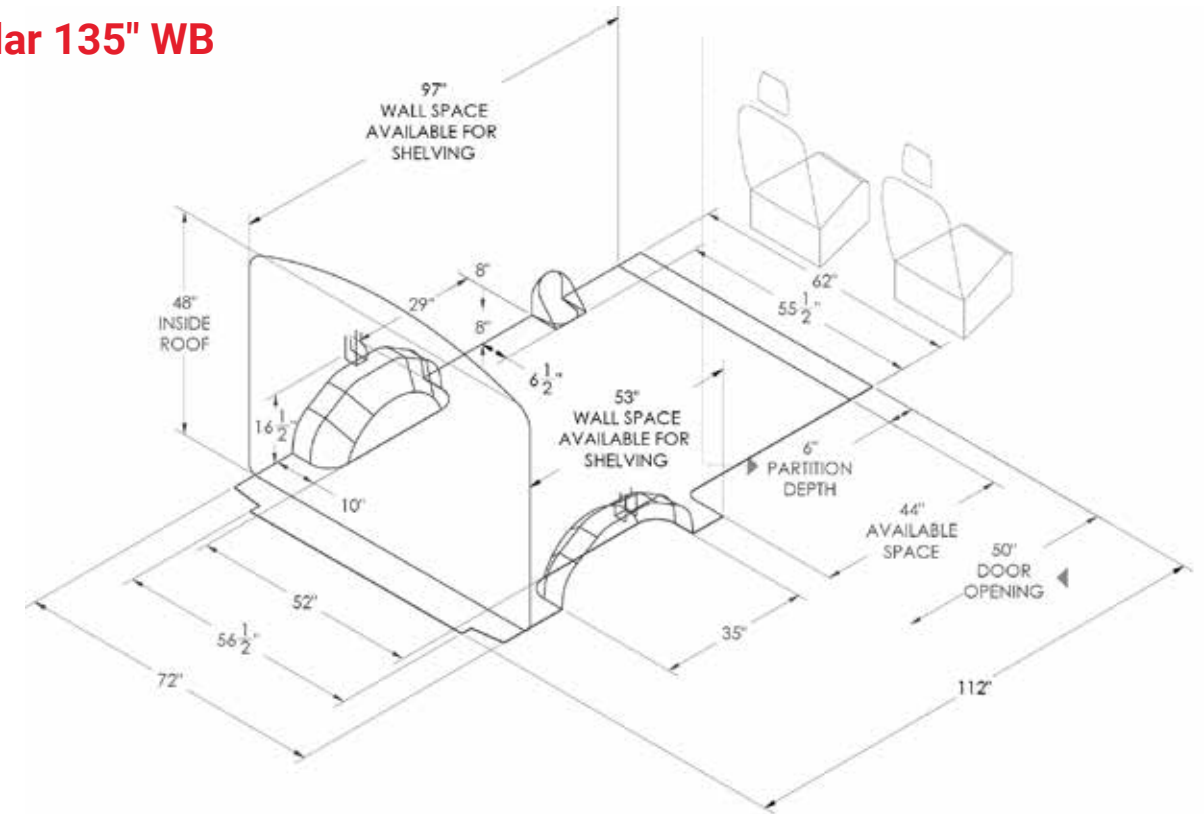

Extended 155" WB

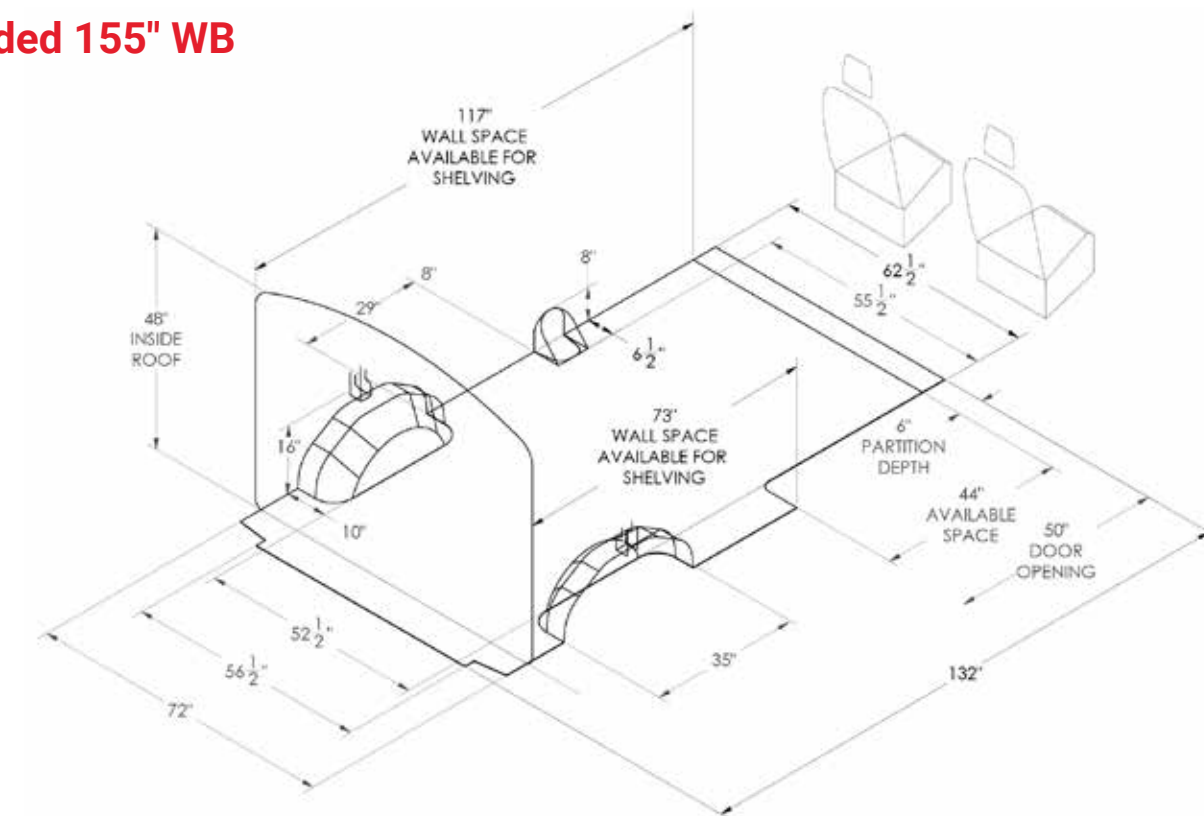

7500+

Vans Upfitted Per Year

Your Express & Savana Customizing Starts Here.

Let Advantage Outfitters
make your van work-ready!

95% Stock Orders Completed in
48 Hours or Less



Serving the tri-state region

New York · New Jersey · Connecticut · Pennsylvania

Contact Your Savanna/Express Dealer



WEST
255 West Street
South Hackensack,
NJ 07606

EAST
107 E. Hawthorne Ave.
Valley Stream,
NY 11580

sales@advantageoutfitters.com

866.925.4844

advantageoutfitters.com